

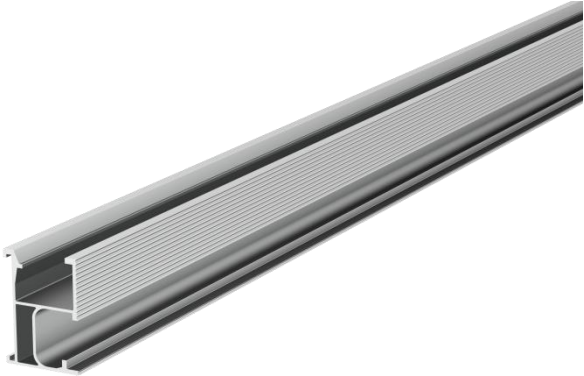

Elite Rail





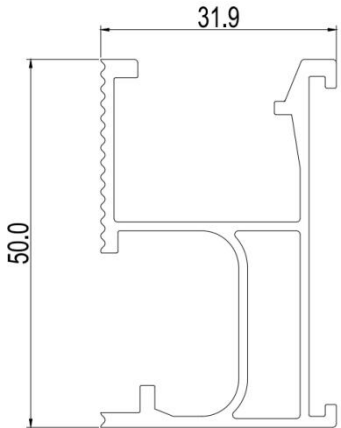

Component

	
<p>Elite Rail Part No.: ER-R-ELT/XXXX</p>	<p>Elite Rail, Black Anodised Part No.: ER-R-ELT/XXXX/BA</p>

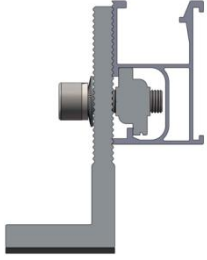
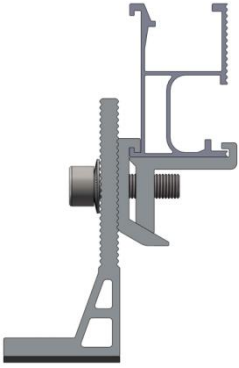
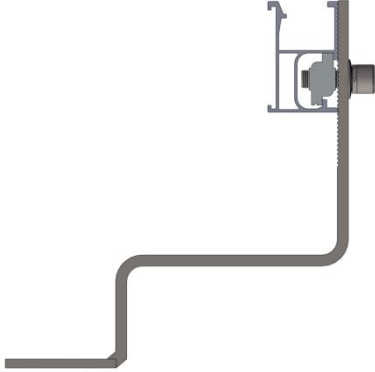
Technical Specification

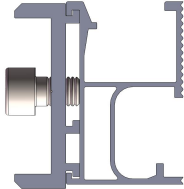
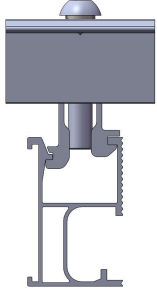
Roof type	For Clenergy' s PV Mounting System	
Dimension	W31.9mm*H50.0mm	
Length	3600, 4400, 4600, 4700 and 4800mm	
Packaging	90 pcs per pack; 4 packs (360 pcs) per pallet	
Weight	0.695 Kg/m	
Material	AL6005-T5	
Color	ER-R-ELT/XXXX: Silver (Anodised (no less than 5um, excluding machined surfaces)) ER-R-ELT/XXXX/BA: Black (Black Anodised)	
Standard	AS/NZS 1170.2:2021	

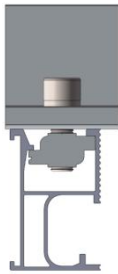
Assembly

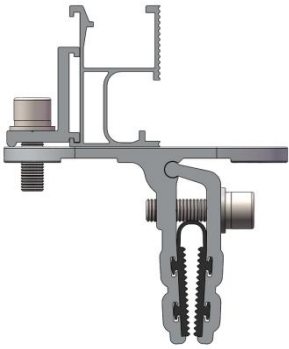
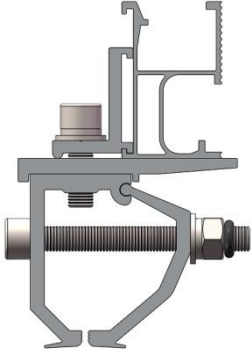
		
<p>Installed with Tin Interface</p>	<p>Installed with ezClick Tin Interface</p>	<p>Installed with Tile Interface</p>
		
<p>Installed with Elite rail Splice</p>	<p>Installed with ECO rail Splice</p>	<p>Installed with Zano Clamp</p>
		
<p>Installed with Akashi Clamp</p>	<p>Installed with Standard Clamp</p>	<p>Installed with Klip-lok Interface 400-700HS with Cross Connector Clamp</p>
		
<p>Installed with Klip-lok Interface for longline 305 with Cross Connector Clamp</p>	<p>Installed with Brooklyn Klip-lok Clamp with Cross Connector Clamp and Plate Kit</p>	